

Panasonic®



Heavy duty MP3 CD player/weather band receiver

Model: **CQ-5250U**

Operating Instructions



WMA

MP3

- Please read these instructions (including “Limited Warranty” and “Customer Services Directory”) carefully before using this product and keep this manual for future reference.

Safety Information

■ Read the operating instructions for the unit and all other components of your car audio system carefully before using the system. They contain instructions about how to use the system in a safe and effective manner. Panasonic assumes no responsibility for any problems resulting from failure to observe the instructions given in this manual.

■ This manual uses pictographs to show you how to use the product safely and to alert you to potential dangers resulting from improper connections and operations. The meanings of the pictographs are explained below. It is important that you fully understand the meanings of the pictographs in order to use this manual and the system properly.



Warning

This pictograph intends to alert you to the presence of important operating instructions and installation instructions. Failure to heed the instructions may result in severe injury or death.



Caution

This pictograph intends to alert you to the presence of important operating instructions and installation instructions. Failure to heed the instructions may result in injury or material damage.



Warning

Observe the following warnings when using this unit.

- ❑ **The driver should not operate the system while driving.**

Operating the system will distract the driver from looking ahead of the vehicle and can cause accidents. Always stop the vehicle in a safe location and use the parking brake before operating the system.

- ❑ **Use the proper power supply.**

This product is designed for operation with a negative grounded 12 V DC battery system. Never operate this product with other battery systems, especially a 24 V DC battery system.

- ❑ **Protect the Deck Mechanism.**

Do not insert any foreign objects into the slot of this unit.

- ❑ **Do not disassemble or modify the unit.**

Do not disassemble, modify the unit or attempt to repair the product yourself. If the product needs to be repaired, consult your dealer or an authorized Panasonic Servicenter.

- ❑ **Do not use the unit when it is out of order.**

If the unit is out of order (no power, no sound) or in an abnormal state (has foreign objects in it, is exposed to water, is smoking, or smells), turn it off immediately and consult your dealer.

- ❑ **Any NOAA broadcast weather report, including current and forecasts, may not reflect your actual weather conditions at your exact time and location. You should always pay attention to your actual weather conditions to make safe decisions accordingly.**

Observe the following warnings when installing.

- ❑ **Disconnect the lead from the negative (–) battery terminal before installation.**

Wiring and installation with the negative (–) battery terminal connected may cause electrical shock and injury due to a short circuit.

Some cars equipped with the electrical safety system have specific procedures of battery terminal disconnection.

FAILURE TO FOLLOW THE PROCEDURE MAY LEAD TO THE UNINTENDED ACTIVATION OF THE ELECTRICAL SAFETY SYSTEM RESULTING IN DAMAGE TO THE VEHICLE AND PERSONAL INJURY OR DEATH.

- ❑ **Never use safety-related components for installation, grounding, and other such functions.**

Do not use safety-related vehicle components (fuel tank, brake, suspension, steering wheel, pedals, airbag, etc.) for wiring or fixing the product or its accessories.

- ❑ **Installing the product on the air bag cover or in a location where it interferes with airbag operation is prohibited.**

- ❑ **Check for piping, gasoline tank, electric wiring, and other items before installing the product.**

If you need to open a hole in the vehicle chassis to attach or wire the product, first check where the wire harness, gasoline tank, and electric wiring are located. Then open the hole from outside if possible.

- ❑ **Never install the product in a location where it interferes with your field of vision.**
- ❑ **Never have the power cord branched to supply other equipment with power.**
- ❑ **After installation and wiring, you should check the normal operation of other electrical equipment.**
The continuation of their using in abnormal conditions may cause fire, electrical shock or a traffic accident.
- ❑ **In the case of installation to an airbag equipped car, confirm warnings and cautions of the vehicle manufacturer before installation.**
- ❑ **Make sure the leads do not interfere with driving or getting in and out of the vehicle.**
- ❑ **Insulate all exposed wires to prevent short circuiting.**

 **Caution**

Observe the following cautions when using this unit.

- ❑ **Keep the sound volume at an appropriate level.**
Keep the volume level low enough to be aware of road and traffic conditions while driving.
- ❑ **Do not insert or allow your hand or fingers to be caught in the unit.**
To prevent injury, do not get your hand or fingers caught in moving parts or in the disc slot. Especially watch out for infants.
- ❑ **This unit is designed for use exclusively in automobiles.**
- ❑ **Do not operate the unit for a prolonged period with the engine turned off.**
Operating the audio system for a long period of time with the engine turned off will drain the battery.
- ❑ **Do not expose the unit to direct sunlight or excessive heat.**
Otherwise these will raise the interior temperature of the unit, and it may lead to smoke, fire, or other damage to the unit.
- ❑ **Do not use the product where it will be exposed to water, moisture, or dust.**
Exposure of the unit to water, moisture, or dust may lead to smoke, fire, or other damage to the unit. Make especially sure that the unit does not get wet in car washes or on rainy days.
- ❑ **To ensure safety, never attempt to preset stations while you are driving.**
- ❑ **Depending upon the transmission condition of electro-magnetic waves, the geographical reasons and/or the weather conditions, you may not receive the NOAA radio partially or at all.**
- ❑ **Make sure that your weather radio can receive properly before driving, especially, before use in a critical condition.**
- ❑ **Set the volume level to low enough before the AUX connection is completed.**
Failure to observe this, the loud noise may come out and damage your speakers and your hearing. Direct connection of the speaker/headphone output of an external device without any attenuator may distort sound or damage the connected external device.

Observe the following cautions when installing.

- ❑ **Refer wiring and installation to qualified service personnel.**
Installation of this unit requires special skills and experience. For maximum safety, have it installed by your dealer. Panasonic is not liable for any problems resulting from your own installation of the unit.
- ❑ **Follow the instructions to install and wire the product.**
Not following the instructions to properly install and wire the product could cause an accident or fire.
- ❑ **Take care not to damage the leads.**
When wiring, take care not to damage the leads. Prevent them from getting caught in the vehicle chassis, screws, and moving parts such as seat rails. Do not scratch, pull, bend or twist the leads. Do not run them near heat sources or place heavy objects on them. If leads must be run over sharp metal edges, protect the leads by winding them with vinyl tape or similar protection.
- ❑ **Use the designated parts and tools for installation.**
Use the supplied or designated parts and appropriate tools to install the product. The use of parts other than those supplied or designated may result in internal damage to the unit. Faulty installation may lead to an accident, a malfunction or fire.
- ❑ **Do not block the air vent or the cooling plate of the unit.**
Blocking these parts will cause the interior of the unit to overheat and will result in fire or other damage.
- ❑ **Do not install the product where it is exposed to strong vibrations or is unstable.**
Avoid slanted or strongly curved surfaces for installation. If the installation is not stable, the unit may fall down while driving and this can lead to an accident or injury.
- ❑ **Installation Angle**
The product should be installed in a horizontal position with the front end up at a convenient angle, but not more than 30°.
The user should bear in mind that in some areas there may be restrictions on how and where this unit must be installed. Consult your dealer for further details.
- ❑ **Wear gloves for safety. Make sure that wiring is completed before installation.**
- ❑ **To prevent damage to the unit, do not connect the power connector until the whole wiring is completed.**
- ❑ **Do not connect more than one speaker to one set of speaker leads. (except for connecting to a tweeter)**

 **Caution**

- **PLEASE FOLLOW THE LAWS AND REGULATIONS OF YOUR STATE, PROVINCE OR COUNTRY FOR WIRING, INSTALLATION, AND USE OF THIS UNIT AND THE DEVICES TO BE CONNECTED.**

Find the model number and serial number on either the back or bottom of the unit. Please record them in the space below and retain this booklet as a permanent record of your purchase to help with identification in case of theft.

MODEL NUMBER CQ-5250U SERIAL NUMBER _____
DATE PURCHASED _____ FROM _____

Safety Information (continued)

Warning

TO REDUCE THE RISK OF FIRE OR ELECTRIC SHOCK OR PRODUCT DAMAGE, DO NOT EXPOSE THIS APPLIANCE TO RAIN, SPLASHING, DRIPPING OR MOISTURE.

Caution

THIS PRODUCT IS A CLASS I LASER PRODUCT. USE OF CONTROLS OR ADJUSTMENTS OR PERFORMANCE OF PROCEDURES OTHER THAN THOSE SPECIFIED HEREIN MAY RESULT IN HAZARDOUS RADIATION EXPOSURE. DO NOT OPEN COVERS AND DO NOT REPAIR BY YOURSELF. REFER SERVICING TO QUALIFIED PERSONNEL.

Laser Products:

Wave length: 790 nm

Laser power: No hazardous radiation is emitted with safety protection.

TO REDUCE THE RISK OF FIRE OR ELECTRIC SHOCK, AND ANNOYING INTERFERENCE, USE ONLY THE INCLUDED COMPONENTS.

The following applies only in the U.S.A.

Part 15 of the FCC Rules

FCC Warning:

Any unauthorized changes or modifications to this equipment would void the user's authority to operate this device.

Customer Services Directory

U.S.A.

Obtain Product Information and Operating Assistance; locate your nearest Dealer or Servicenter; purchase Parts and Accessories; or make Customer Service and Literature requests by visiting our Web Site at:

<http://www.panasonic.com/support>

or, contact us via the web at:

<http://www.panasonic.com/contactinfo>

You may also contact us directly at:

1-800-211-PANA (7262),

Monday-Friday 9 am-9 pm; Saturday-Sunday 10 am-7 pm, EST.

For hearing or speech impaired TTY users,

TTY : 1-877-833-8855

Accessory Purchases:

Purchase Parts, Accessories and Instruction Books online for all Panasonic Products by visiting our Web Site at:

<http://www.pasc.panasonic.com>

or, send your request by E-mail to:

npcparts@panasonic.com

You may also contact us directly at:

1-800-332-5368 (Phone) 1-800-237-9080 (Fax Only) (Monday-Friday 9 am to 8 pm, EST.)

Panasonic Services Company

20421 84th Avenue South, Kent, WA 98032

(We accept Visa, MasterCard, Discover Card, American Express, and Personal Checks)

For hearing or speech impaired TTY users,

TTY : 1-866-605-1277

Service in Puerto Rico

Panasonic Puerto Rico, Inc.

Panasonic Sales Company

Factory Servicenter:

Ave. 65 de Infantería, Km. 9.5, San Gabriel Industrial Park,

Carolina, Puerto Rico 00985

Phone (787) 750-4300, Fax (787) 768-2910

Limited Warranty

U.S.A.

PANASONIC CONSUMER ELECTRONICS COMPANY,
DIVISION OF PANASONIC CORPORATION OF NORTH AMERICA
One Panasonic Way, Secaucus, New Jersey 07094

PANASONIC SALES COMPANY,
DIVISION OF PANASONIC PUERTO RICO, INC.
Ave. 65 de infantería, Km. 9.5, San Gabriel Industrial Park
Carolina, Puerto Rico 00985

PANASONIC AUTO PRODUCTS LIMITED WARRANTY

LIMITED WARRANTY COVERAGE

If your product does not work properly because of defects in materials and workmanship.

Panasonic Consumer Electronics Company or Panasonic Sales Company (collectively referred to as "the warrantor") will, for the length of the period indicated in the chart below, which starts with the date of original purchase ("warranty period"), at its option either (a) repair your product with new or refurbished parts, or (b) replace it with a new or refurbished product. The decision to repair or replace will be made by the warrantor.

Categories	Parts	Labor
Audio Components (except items listed below)	One (1) Year	One (1) Year
MXE Series Audio Components (except items listed below)	Two (2) Years	Two (2) Years
Speakers Defective Car Audio Speakers under warranty must be exchanged at the place of purchase. Contact your Dealer for details.	One (1) Year	Not Applicable
Accessories (in exchange for defective items)	Ninety (90) Days	Not Applicable

During the "Labor" warranty period, there will be no charge for labor. During the "Parts" warranty period, there will be no charge for parts. You must carry in or mail in your product prepaid during the warranty period. If non-rechargeable batteries are included, they are not warranted. This warranty only applies to products purchased and serviced in the United States or Puerto Rico. This warranty is extended only to the original purchaser of a new product which was not sold "as is". A purchase receipt or other proof of the original purchase date is required for warranty service.

CARRY-IN OR MAIL-IN SERVICE

For Carry-In or Mail-In Service in the United States, call 1-800-211-PANA (7262) or visit

Panasonic Web Site: <http://www.panasonic.com>

For assistance in Puerto Rico, call Panasonic Sales Company (787)-750-4300 or fax (787)-768-2910.

LIMITED WARRANTY LIMITS AND EXCLUSIONS

This warranty ONLY COVERS failures due to defects in materials and workmanship, and DOES NOT COVER normal wear and tear or cosmetic damage. The warranty ALSO DOES NOT COVER damages which occurred during shipment, failures which are caused by products not supplied by the warrantor, failures which result from accident, misuse, abuse, neglect, bug infestation, mishandling, misapplication, alteration, faulty installation, set-up adjustment, maladjustment of consumer control, improper maintenance, improper antenna, inadequate signal reception or pickup, power line surge, improper voltage supply, lightning, modification, commercial use (such as use in hotels, offices, restaurants, or other business uses) or rental use of the product, or service by anyone other than the technician from Factory Servicenter or other authorized service centers, or damage that is attributable to acts of God.

THERE ARE NO EXPRESS WARRANTIES EXCEPT AS LISTED UNDER "LIMITED WARRANTY COVERAGE". THE WARRANTOR IS NOT LIABLE FOR INCIDENTAL OR CONSEQUENTIAL DAMAGES RESULTING FROM THE USE OF THIS PRODUCT, OR ARISING OUT OF ANY BREACH OF THIS WARRANTY. (As examples, this excludes damages for lost time, cost of having someone remove or re-install an installed unit if applicable, travel to and from the servicer, and loss of media, data or other memory contents. The items listed are not exclusive, but are for illustration only.) **ALL EXPRESS AND IMPLIED WARRANTIES, INCLUDING THE WARRANTY OF MERCHANTABILITY, ARE LIMITED TO THE PERIOD OF THE LIMITED WARRANTY.**

Some states do not allow the exclusion or limitation of incidental or consequential damages, or limitations on how long an implied warranty lasts, so the exclusions may not apply to you.

This warranty gives you specific legal rights and you may also have other rights which vary from state to state. If a problem with this product develops during or after the warranty period, you may contact your dealer or Servicenter. If the problem is not handled to your satisfaction, then write to warrantor's Consumer Affairs Department at the addresses of the warrantor.

PARTS AND SERVICE WHICH ARE NOT COVERED BY THIS LIMITED WARRANTY ARE YOUR RESPONSIBILITY.

Customer's Record

Model

No. _____

Serial

No. _____

Dealer's

No. _____

Code

No. _____

Dealer's

Address _____

Date of

Purchase _____

Before Reading These Instructions

Panasonic welcomes you to our ever growing family of electronic product owners. We know that this product will bring you many hours of enjoyment. Our reputation is built on precise electronic and mechanical engineering, manufactured with carefully selected components and assembled by people who take pride in their work. Once you discover the quality, reliability, and value we have built into this product, you too will be proud to be a member of our family.

Accessories

1. Operating Instructions1
2. Supplied Hardware.....1 set (⇒ page 19)

Contents

Safety Information	2	Installation	18
Customer Services Directory	4	Electrical Connections	22
Limited Warranty	5	Troubleshooting	23
Before Reading These Instructions	6	If You Suspect Something Wrong, Common, Radio, CD, MP3/WMA, USB, Product Servicing	
Features	7	Error Display Messages	27
Front AUX terminal, Sound Control, USB Connector		CD/MP3/WMA, USB	
Preparation	8	Maintenance	29
First time power on, Clock adjustment		Cleaning this Unit, Caution	
Controls Layout	9	Notes on MP3/WMA	30
General	10	Cautions as to compressed audio files, Cautions as to the display of this unit, Cautions as to compressed audio files, Common	
Sound Controls	11	Notes on Discs	32
SQ (Sound Quality) , Audio Modes (Bass/Treble/Balance/Fader)		How to hold the disc, Unusable discs, Disc insert, Disc cleaning, Notes on CD-Rs/RWs	
Radio	12	Specifications	33
Band, Frequency adjustment, Auto Preset Memory (APM), Preset station selection, Manual Preset Memory, Tuning in a Weather Band Station		General, FM Stereo Radio, AM Radio, Weather Band Radio, CD Player	
CD/MP3/WMA Player	14		
Disc loading/ejection, Track/File selection, Folder selection (MP3/WMA), Pause, Display change, Scan, Repeat, Random			
USB (MP3/WMA)	16		
USB device connection, File selection, Folder selection, Pause, Display change, Scan, Repeat, Random			

Features

Front AUX terminal

Your mobile audio player and other devices are connectable to this unit without any difficulty.

Sound Control

SQ (Sound Quality)

You have four preset modes (FLAT, ROCK, POP and VOCAL).

USB Connector

The USB connector is equipped on the front panel.

Connection of a USB memory (not included) to the USB connector via a USB extension cable (not included) allows users to enjoy MP3/WMA files stored on the USB memory (not included) in the car.

Preparation

First time power on

- 1 Turn the key in the ignition until the accessory indicator lights.
- 2 Press **[SRC] (PWR)**.

Clock adjustment

The 12-hour system is used for the clock.

- 1 Press **[DISP] (CLK)**.

 (Clock display)

- 2 Hold down **[DISP] (CLK)** for 2 sec. or more.

 Hour blinks

- 3 Adjust the hour.

[▶▶] : Sets ahead.

[◀◀] : Sets back.

 Hour entered

- 4 Press **[DISP] (CLK)**.

 Minute blinks

- 5 Adjust the minute.

[▶▶] : Sets ahead.

[◀◀] : Sets back.

 Minute entered

- 6 Press **[DISP]**.

 Completed

Notes:

- "ADJUST" is displayed before adjusting the clock.
- Hold down **[▶▶]** or **[◀◀]** to change numbers rapidly.
- When you want to readjust the time, repeat steps **2** to **6**.

Controls Layout

SRC Source (⇒ page 10)

PWR Power (⇒ page 10)

BAND (⇒ page 12)

▶|| Play/Pause

(⇒ page 14,16)

APM Auto Preset Memory

(⇒ page 12)

MUTE (⇒ page 10)

SQ Sound Quality

(⇒ page 11)

VOLUME (⇒ page 10)

PUSH SEL Select

(⇒ page 11)

Disc slot

▲ (Eject) (⇒ page 14)

DISP Display (⇒ page 10, etc.)

CLK Clock (⇒ page 8)

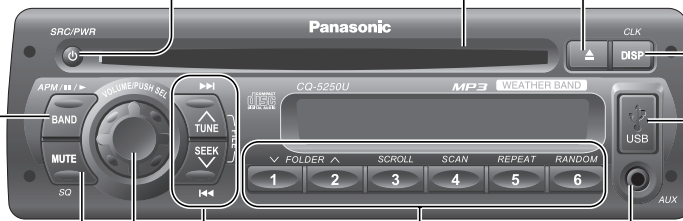

USB Connector
(⇒ page 16)

Preset Buttons [1] to [6]
(⇒ page 12)

SCROLL (⇒ page 14, etc.)

SCAN/REPEAT/RANDOM (⇒ page 14,16)

FOLDER \wedge/\vee (⇒ page 14, 16)

AUX
From line output of
external sound/audio
device (ex. Silicon-
audio player, HDD
player, etc.)

TUNE/SEEK \lll/\ggg (⇒ page 12)

FILE (Track/File) \lll/\ggg (⇒ page 14, 16)

General

Source Selection

The source changes as follows every time **[SRC]** (Source) is pressed.

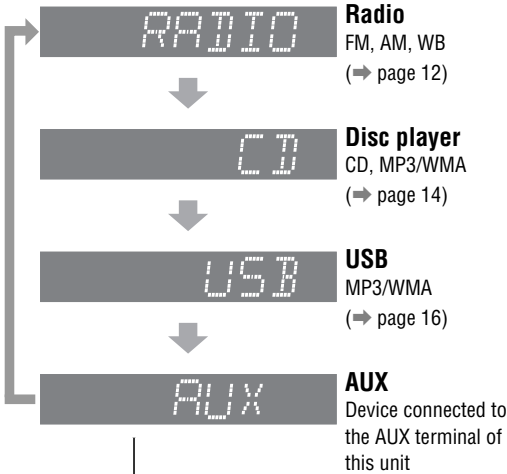

Display Change

Press **[DISP]** to switch to the clock display.

When the power is off:

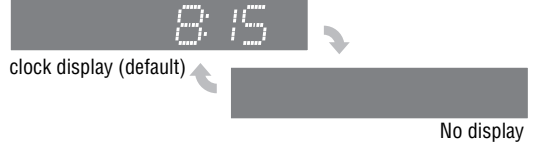

Note: "ADJUST" is displayed when the clock is not adjusted.
(⇒ page 8)

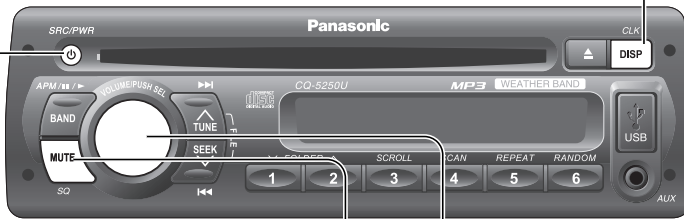

Power

Turn the key in the ignition until the accessory indicator lights.

Power on: Press **[SRC](PWR)**.



Power off: Hold down **[SRC](PWR)** for more than 1 second.

Volume

Turn the knob clockwise to increase volume, and counterclockwise to decrease volume.



Volume level (0 to 40)
(default:18)

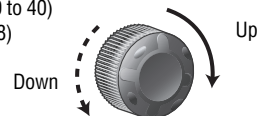

Mute

Press **[MUTE]** to mute the sound completely.

Press **[MUTE]** again to cancel.



Sound Controls

SQ (Sound Quality)

SQ is a function that can call up various sound types at the touch of button in accordance with your listening music type. Press **[SQ]** for more than 2 seconds to select the sound type as follows:

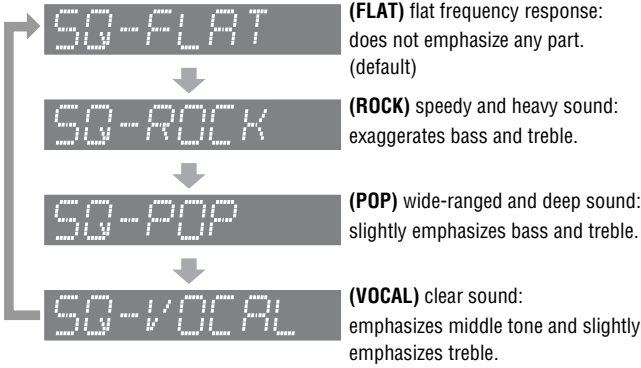

SQ indicator



Audio Modes (Bass/Treble/Balance/Fader)

- 1 Push **[SEL]** to select the audio mode.
- 2 Turn **[VOLUME]** clockwise or counterclockwise to change each level.

VOL 18 (Volume)

(Setting Range: 0 to 40, default: 18)

VOL 20

①: Up
②: Down

BASS (Bass)

(Setting Range: -12 dB to +12 dB by 2 dB, default: 0 dB)

BAS+ 6dB

①: Increased
②: Decreased

TREBLE (Treble)

(Setting Range: -12 dB to +12 dB by 2 dB, default: 0 dB)

TRE+ 6dB

①: Increased
②: Decreased

BALANCE (Balance)

(Setting Range: 15 levels each and 0 (center), default: CNT)

BAL L 15

①: Right enhanced
②: Left enhanced

FADER (Fader)

(Setting Range: 15 levels each and 0 (center), default: CNT)

FAD F 15

①: Front enhanced
②: Rear enhanced

Note: If no operation takes place for more than 5 seconds in audio mode (2 seconds in volume mode), the display returns to the regular mode.

Radio

Band

Press **[BAND]** to change the band.



Weather Band
(→ page 13)

⚠ Caution

To ensure safety, never attempt to preset stations while you are driving.

ST (FM stereo) indicator

lights while receiving an FM stereo signal.

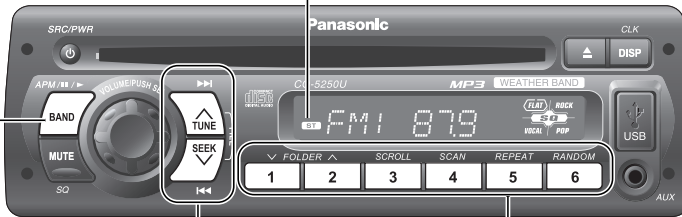

Frequency adjustment

[TUNE/SEEK ◀◀]: Lower

[TUNE/SEEK ▶▶]: Higher

Note: Hold down for 0.5 sec. or more and release for station search.

Preset station selection

Press the corresponding preset button from **[1]** to **[6]** to tune in a preset station.

Auto Preset Memory (APM)

Press and hold **[BAND]** (**APM**: auto preset memory) for more than 2 seconds.

- The 6 stations with good reception will be automatically saved in the memory under preset buttons from **[1]** to **[6]**.
- Once set, the preset stations are sequentially scanned for 5 seconds each.
- Press one of the buttons from **[1]** to **[6]** to stop sequentially scan.

Note: New stations overwrite existing saved stations.

Manual Preset Memory

1 Use manual or seek tuning to find a station.

2 Press and hold one of the preset buttons from **[1]** to **[6]** until the display blinks once.

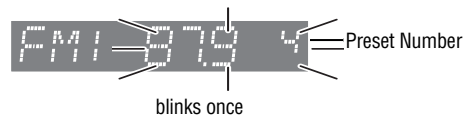

Note: New stations overwrite existing saved stations.

Tuning in a Weather Band Station

- 1 Press **[BAND]** to select WB (Weather Band).
(→ page 12)
- 2 Press any of the buttons **[1]** to **[6]** to monitor the preset station.

Note: The weather band (CH1-6) has been preset. CH7 is selected by pressing **[^]** or **[v]**.

Weather Band Stations

National Weather Radio Broadcasts from over 380 locations throughout the U.S. on seven VHF/FM frequencies.

Tune to weather band to receive continuous weather information 24 hours a day on one of the following frequencies.

1. 162.550 MHz
2. 162.400 MHz
3. 162.475 MHz
4. 162.425 MHz
5. 162.450 MHz
6. 162.500 MHz
7. 162.525 MHz

Occasionally the frequency of an existing or planned station must be changed because of unexpected radio frequency interfere with adjacent NOAA weather Radio Stations and/or with other Government or commercial Operations within the area. If you have a question concerning NOAA Weather Radio, please contact your nearest National Weather Service Office.

Warning

Any NOAA broadcast weather report, including current and forecasts, may not reflect your actual weather conditions at your exact time and location. You should always pay attention to your actual weather conditions to make safe decisions accordingly.

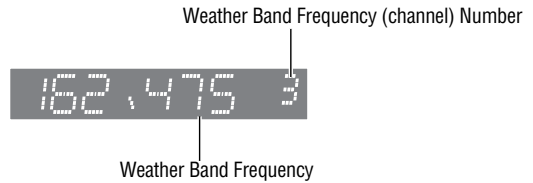

CD/MP3/WMA Player

⚠ Cautions

- Do not insert a disc when the **DISC** indicator lights.
- This unit does not support 8 cm {3"} discs.
- Do not use irregularly shaped discs. (⇒ page 32)
- Do not use discs that have a seal or label attached.
- Do not insert foreign matter into the disc slots.
- Refer to the section on "Notes on CD-Rs/RWs" (⇒ page 32).
- Refer to the section on "Notes on MP3/WMA". (⇒ page 30)
- This unit does not support a MIX mode CD (a CD containing both CD-DA and compressed audio data). In case of using such a CD, problems may occur such as anacoustic playback.

Pause

Press **[BAND]** (||/▶).

Press again to cancel.

Disc loading/ejection

Loading

Load a disc in with the printed side facing up.

Notes:

- The power will be turned on automatically when a disc is loaded.
- Playback will start automatically after the player recognized the loaded disc as an ordinary music CD or MP3/WMA disc.

Ejection

Press **[▲]** to eject the disc.

**REP (Repeat)/ R▶ (Random)/
FOLDER indicator**

**DISC (DISC)
indicator**

**Display change
(⇒ page 15)**

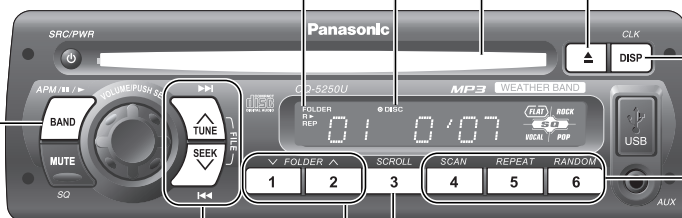

Track/File selection

[FILE ▶▶]: Next track/file

[FILE ◀◀]: Preceding track/file (press twice)

Note: Hold down for fast forward/reverse.

Folder selection (MP3/WMA)

[FOLDER ▲]: Next folder

[FOLDER ▼]: Preceding folder

Text Scroll

Scan, Repeat, Random (⇒ page 15)

Display change

Press **[DISP]** to change the display.

Notes:

- For scrolling text, press **[3] (SCROLL)**.
- "NO TEXT" is displayed when there is no information on the disc.

CD-DA



* CD TEXT Display

Disc title and Track title name are displayed.

MP3/WMA

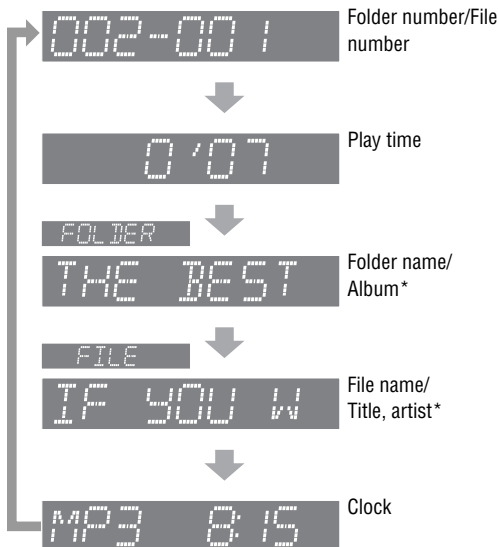

* ID3 Tag ON/OFF

Hold down **[3] (SCROLL)** for more than 2 seconds.

TAG ON: album title and song title/artist name are displayed.

TAG OFF: folder name/file name are displayed. (Default)

Scan, Repeat, Random

Scan play

The first 10 seconds of each track/file is played in sequence.

Press **[4] (SCAN)**. Track/file number blinks.

Press again to cancel.

Folder scan play (MP3/WMA)

From the next folder, the first 10 seconds of the first file in each folder is played in sequence.

Hold down **[4] (SCAN)** for more than 2 seconds. **FOLDER** lights and folder number blinks.

Hold down again to cancel.

Repeat play

The current track/file is repeated.

Press **[5] (REPEAT)**. **REP** lights.

Press again to cancel.

Folder repeat play (MP3/WMA)

The current folder is repeated.

Hold down **[5] (REPEAT)** for more than 2 seconds. **REP**, **FOLDER** lights.

Hold down again to cancel.

Random play

All the available tracks/files are played in a random sequence.

Press **[6] (RANDOM)**. **R▶** lights.

Press again to cancel.

Folder random play (MP3/WMA)

All the available files in current folder are played in a random sequence.

Hold down **[6] (RANDOM)** for more than 2 seconds. **R▶**, **FOLDER** lights.

Hold down again to cancel.

USB (MP3/WMA)

⚠ Cautions

- Do not connect a USB device directly to this unit. If a USB device is connected directly to this unit and an accident occurs, or if the brakes are applied suddenly, the driver or passenger may bump into the USB device and may be injured.
- Connect your USB device to your car audio using a standard USB extension cable (5 m or less).
- Position the USB device and USB extension cable so that they do not interfere with your driving.
- Do not connect any USB device other than a USB memory or a USB audio player. Do not connect multiple USB devices to the USB connector. Supplying power to multiple USB devices from the connector could cause overheating and smoking.

Compatible USB devices

- **USB Mass Storage Class**
For details as to whether your USB memory/USB Audio is compatible with USB Mass Storage Class, please contact the USB memory/USB Audio manufacturer.
- **USB Standard Compatibility 1.1/2.0 Full Speed**
- **File System FAT12/16/32**
- **Maximum current less than 500 mA**
- **Capacity less than 4 GB (1 partition)**

Pause

Press **[BAND]** (II / ►).
Press again to cancel.

USB device connection

Open the USB connector cover and connect a USB device to this unit.

Notes:

- When connecting (disconnecting) a USB device, turn down the volume of the unit.
- When connecting a USB device, make sure the connector is pushed all the way into the socket.

**REP (Repeat) / R► (Random) /
FOLDER indicator**

USB indicator
lights when a USB
device is loaded

Display change
(⇒ page 17)

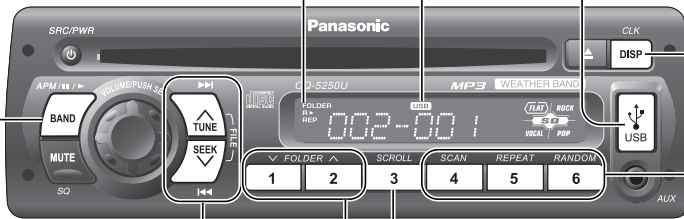

Text Scroll

Scan, Repeat, Random (⇒ page 17)

File selection

[FILE ►►]: Next file

[FILE ◀◀]: Preceding file (press twice)

Note: Hold down for fast forward/reverse.

Folder selection

[FOLDER ▲]: Next folder

[FOLDER ▼]: Preceding folder

Notes:

- Refer to the section on "Notes on MP3/WMA". (→ page 30)
- Do not leave the USB device for long periods of time in places inside the car where the temperature rises too high.
- This unit may not operate correctly if a cable other than a USB standard cable is used.
- To prevent dirt and dust from adhering to the USB connector, close the cover of this unit when not in use.
- Back up any important data beforehand. We cannot accept responsibility for any lost data.
- The use of USB devices that contain data files other than MP3/WMA format is not recommended.
- A file with a play time exceeding 1 000 minutes will not play correctly to the end of the track.
- Playback or display may not be possible depending on the type of USB device or the condition of the recording.
- Depending on the connected USB memory, the order in which the files are played back may differ from the order in which the files were stored.
- Connection of an iPod to the USB connector of this unit is not supported.

Display change

Press **[DISP]** to change the display.

Notes:

- For scrolling text, press **[3] (SCROLL)**.
- "NO TEXT" is displayed when there is no information on the USB device.

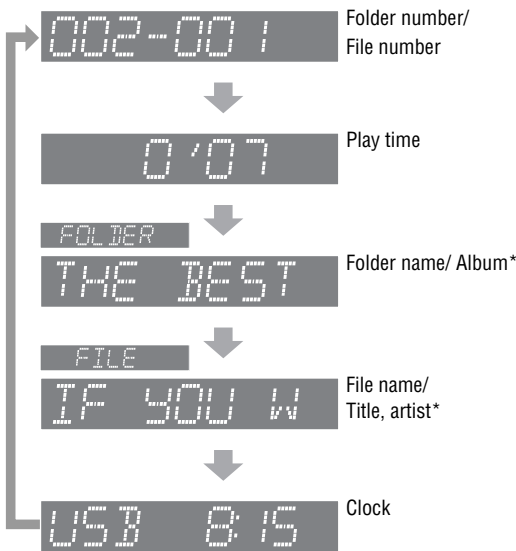

* ID3 Tag ON/OFF

Hold down **[3] (SCROLL)** for more than 2 seconds.

TAG ON: album title and song title/artist name are displayed.

TAG OFF: folder name/file name are displayed. (Default)

Scan, Repeat, Random

Scan play

The first 10 seconds of each file is played in sequence.

Press **[4] (SCAN)**. File number blinks.

Press again to cancel.

Folder scan play

From the next folder, the first 10 seconds of the first file in each folder is played in sequence.

Hold down **[4] (SCAN)** for more than 2 seconds. **FOLDER** lights and folder number blinks.

Hold down again to cancel.

Repeat play

The current file is repeated.

Press **[5] (REPEAT)**. **REP** lights.

Press again to cancel.

Folder repeat play

The current folder is repeated.

Hold down **[5] (REPEAT)** for more than 2 seconds. **REP**, **FOLDER** lights.

Hold down again to cancel.

Random play

All the available files are played in a random sequence.

Press **[6] (RANDOM)**. **R▶** lights.

Press again to cancel.

Folder random play

All the available files in current folder are played in a random sequence.

Hold down **[6] (RANDOM)** for more than 2 seconds. **R▶**, **FOLDER** lights.

Hold down again to cancel.



WARNING

❑ This installation information is designed for experienced installers and is not intended for non-technical individuals. It does not contain warnings or cautions of potential dangers involved in attempting to install this product.

Any attempt to install this product in a vehicle by anyone other than a qualified installer could cause damage to the electrical system and could result in serious personal injury or death.

❑ If your vehicle is equipped with air bag and/or anti-theft systems, specific procedures may be required for connection and disconnection of the battery to install this product.

Before attempting installation of this electronic component, contact your vehicle dealer or manufacturer to determine the required procedure and strictly follow their instructions.

FAILURE TO FOLLOW THE PROCEDURE MAY RESULT IN THE UNINTENDED DEPLOYMENT OF AIR BAGS OR ACTIVATION OF THE ANTI-THEFT SYSTEM RESULTING IN DAMAGE TO THE VEHICLE AND PERSONAL INJURY.

❑ Overview

This product should be installed by a professional. However, if you plan to install this product yourself, your first step is to decide where to install it. The instructions in these pages will guide you through the remaining steps:
(Please refer to the "WARNING" statement above.)

- Identify and label the car wires.
- Connect the vehicle wires to the wires of the power connector.
- Install the unit in the dashboard.
- Check the operation of the unit.

If you encounter problems, please consult your nearest professional installer.

❑ Dashboard Specifications

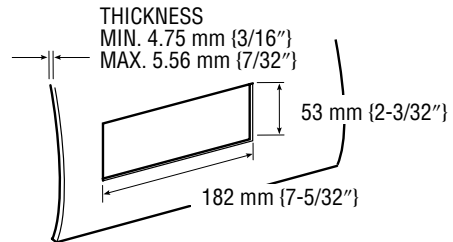

⚠ Caution

This unit operates with a 12 V DC negative ground auto battery system only. Do not attempt to use it in any other system. Doing so could cause serious damage.

Before you begin installation, look for the item which is packed with your unit.

- **Installation Hardware**...Needed for in-dash installation.

❑ Preparation

⚠ Warning

If your vehicle is equipped with air bag and/or anti-theft systems, specific procedures may be required for connection and disconnection of the battery to install this product.

Before attempting installation of this electronic component, contact your vehicle dealer or manufacturer to determine the required procedure and strictly follow their instructions.

FAILURE TO FOLLOW THE PROCEDURE MAY RESULT IN THE UNINTENDED DEPLOYMENT OF AIR BAGS OR ACTIVATION OF THE ANTI-THEFT SYSTEM RESULTING IN DAMAGE TO THE VEHICLE AND PERSONAL INJURY.

- Disconnect the cable from the negative (-) battery terminal (see warning and caution below).
- Remove Mounting Collar ① from the main unit temporarily, which are already mounted at shipment.*

⚠ Caution

Various settings that have been stored in the memory in other on-board equipment (vehicle navigation etc.) may be lost if the battery terminals are disconnected.

Therefore, we recommend to make a record of or to back up the settings before disconnecting the terminals.

After completing installation of the main unit, set the equipment again according to the record.

- Unit should be installed in a horizontal position with the front end up at a convenient angle, but not more than 30°.

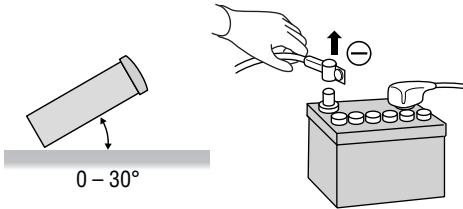

❑ Installation Hardware

No.	Item	Diagram	Q'ty
①	Mounting Collar*		1
②	Plain washer (5 mmø)		2
③	Spring Washer (5 mmø)		2
④	Hex. Nut (5 mmø)		2
⑤	Rear Support Strap		1
⑥	Hex. Bolt (5 mmø × 25 mm)		1
⑦	Toothed Lock Washer (5 mmø)		1
⑧	Removal Tool (U-shaped)		2

❑ Dashboard Installation

Installation Opening

This unit can be installed in any dashboard having an opening as shown below. The dashboard should be 4.75 mm {3/16"} – 5.56 mm {7/32"} thick in order to be able to support the unit.

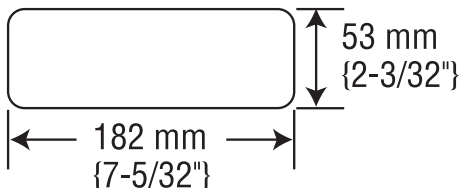

Mounting and removing the Main Unit

□ Mounting Procedures (When using Mounting Collar ①)

The included Mounting Collar ① is designed specially for this unit. Do not use it to attach any other model.

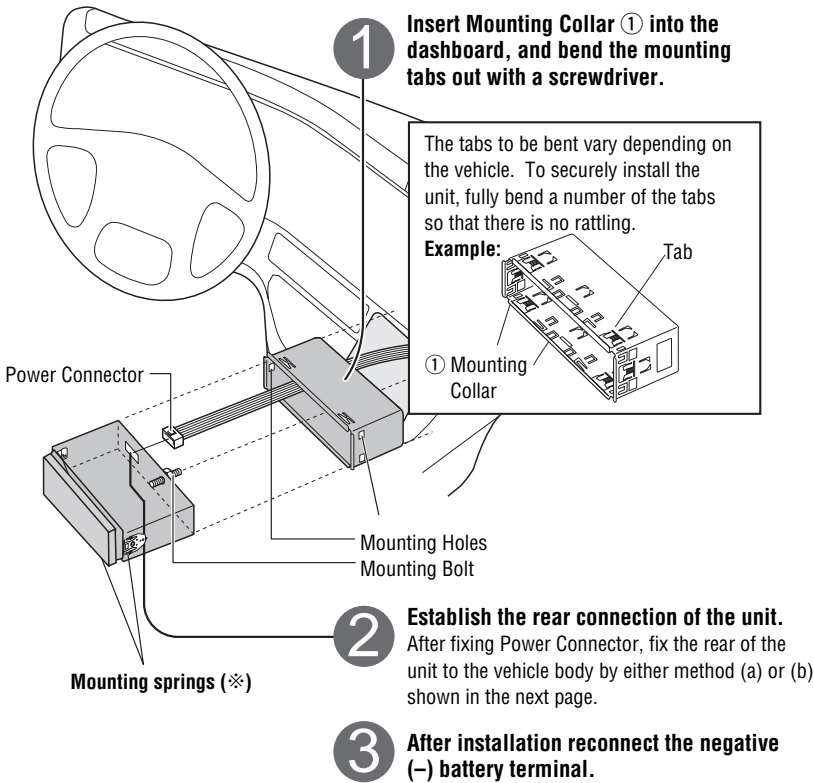

Engage the Mounting Springs (*) in the mounting holes of the Mounting Collar ① firmly.

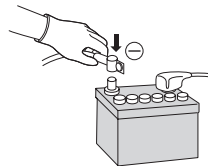
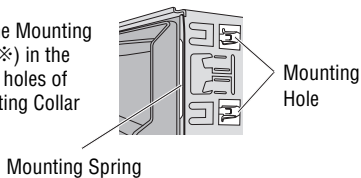

Method for Fixing the Rear of the Unit

(a) Using the rear support strap ⑤

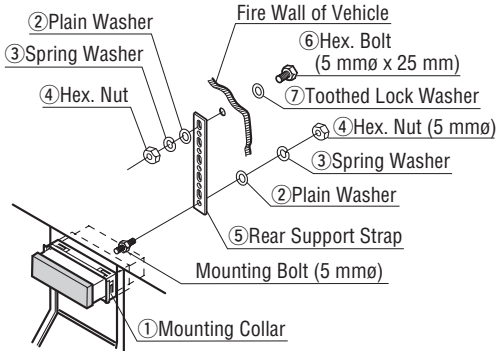

(b) Using the rubber cushion (option)

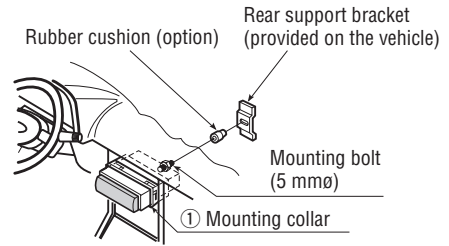

❑ To Remove the Unit from the vehicle's dashboard

Insert each Removal Tool ⑧ and pull.

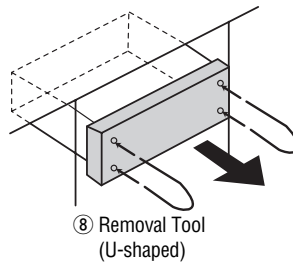

Note: Do not lose Removal Tools. They will be needed to remove the unit from the vehicle's dashboard.

Electrical Connections

⚠ Caution

- This wiring information is for experienced technical individual, for safety reason, please your dealer wire this connection.
- This product is designed to operate with a 12 V DC, negative ground battery system.
- To prevent damage to the unit, be sure to follow the connection diagram below.
- Do not insert the power connector into the unit until the wiring is completed.
- Be sure to insulate any exposed wires from a possible short-circuit from the vehicle chassis. Bundle all cables and keep cable terminals free from touching any metal parts.
- Remember, if your vehicle has a drive computer or a navigation computer, the data of its memory maybe erased when the battery terminals are disconnected.

□ Wiring Diagram

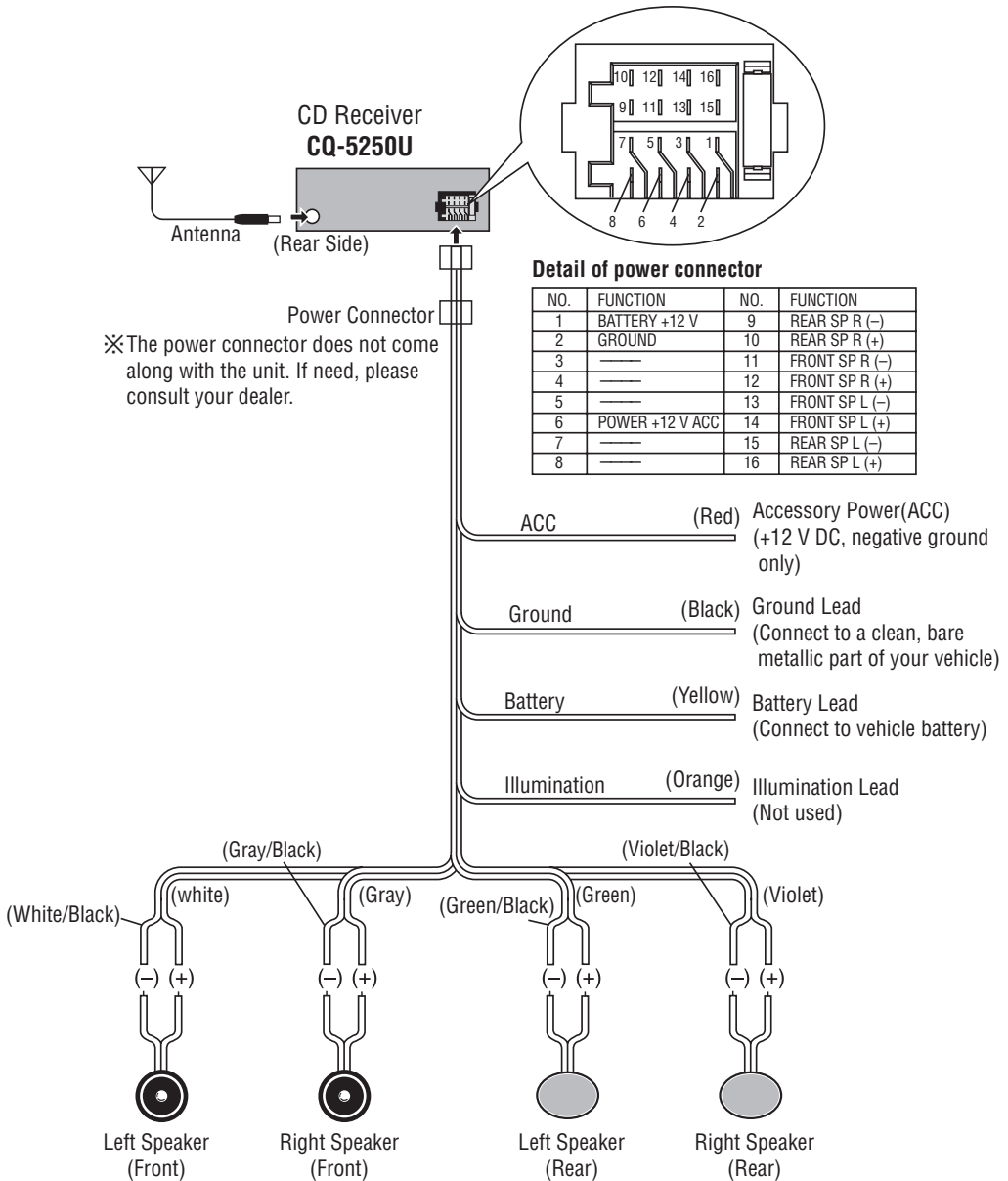

Troubleshooting

If You Suspect Something Wrong

Check and take steps as described below.

If the described suggestions do not solve the problem, it is recommended to take the unit to your nearest authorized Panasonic Servicenter. The product should be serviced only by qualified personnel. Please refer the checking and the repair to professionals. Panasonic shall not be liable for any accidents arising out of neglect of checking the unit or your own repair after your checking.

Never take measures especially for those other than indicated by *italic* letters in "Possible Solution" described below because those are too dangerous for users to handle themselves.

Warning

- Do not use the unit in an irregular condition, for example, without sound, or with smoke or a foul smell, which can cause ignition or electric shock. Immediately stop using the unit and consult your dealer.
- Never try to repair the unit by yourself because it is dangerous to do so.

Common

Problem	Possible cause → Possible solution
No power to the unit	<p>The power cord (battery, power and ground) is connected in the wrong way. → Check the wiring.</p> <p>Fuse blows out. → Eliminate the cause of fuse blowout and replace the fuse with new one. Consult your dealer.</p>
Sound is not generated.	<p>MUTE is set to ON. → Set MUTE to OFF.</p> <p>There is contact between the external mute lead and the chassis. → Connect the external mute lead correctly. If the lead is unused, insulate it.</p> <p>The wiring of speaker lines are not correct, or a break or poor contact arises. → Check the wiring in accordance with the wiring diagram.</p>
Noise	<p>There is an electromagnetic-wave generator such as a cellular phone near the unit or its electrical lines. → Keep an electromagnetic-wave generator such as a cellular phone away from the unit and the wiring of the unit. In case that noise cannot be eliminated due to the wiring harness of the car, consult your dealer.</p> <p>The contact of the ground lead is poor. → Make sure that the ground lead is connected to an unpainted part of the chassis securely.</p>
Noise is made in step with engine revolutions.	<p>Alternator noise comes from the car. → Change the wiring position of the ground lead. → Mount a noise filter on the power supply.</p>
Some operations are not executable.	<p>Some operations are not executable in particular modes such as menu mode. → Read the operating instructions carefully and cancel the mode. If the unit is still out of order, consult your dealer.</p>

Troubleshooting (continued)

No sound from speaker(s)

BALANCE/FADER setting is not appropriate.

⇒ **Readjust BALANCE/FADER.**

There is a break, a short circuit, poor contact or wrong wiring regarding the speaker wiring.

⇒ **Check the speaker wiring.**

The speaker channels are reversed between right and left.

The speaker wiring is confused between right and left.

⇒ **Perform the speaker wiring in accordance with the wiring diagram.**

The sound field is not clear in the stereo mode. Central sound does not settled.

The plus and minus terminals at right and left channels of speakers are connected reversely.

⇒ **Perform the speaker wiring in accordance with the wiring diagram.**

The power fails unintentionally.

The safety device works.

⇒ **Consult your dealer, or your nearest Panasonic Servicenter.**

Radio

Poor reception or noise

Antenna installation or wiring of antenna cable is faulty.

⇒ **Check whether the antenna mounting position and its wiring are correct. In addition, check to see whether the antenna ground is securely connected to the chassis.**

No power is supplied to the antenna amplifier (when using a film antenna, etc.).

⇒ **Check the wiring of the antenna battery lead.**

The number of auto preset stations is less than 6.

The number of receivable stations is less than 6.

⇒ **Move to an area where receivable stations number is maximum, and try pre-setting.**

Preset stations cannot be stored.

The contact of the battery lead is poor, or the battery lead is not always powered.

⇒ **Make sure that the battery lead is connected securely, and preset stations again.**

CD

No playback or disc ejected

The disc is inserted upside down.

⇒ **Insert a disc correctly.**

There is a flaw or foreign material on the disc.

⇒ **Remove the foreign material, or use a flawless disc.**

Sound skipping or noise

There is a flaw or foreign material on the disc.

⇒ **Remove the foreign material, or use a flawless disc.**

Sound skipping due to vibration

The unit is not sufficiently secured.

⇒ **Secure the unit to the console box.**

The unit is tilted at over 30° in the front-to-end direction.

⇒ **Make the angle 30° or less.**

Disc unejectable

Something such as a peeled label obstructs the disc coming out.

⇒ **Consult your dealer.**

The microcontroller in the unit operates abnormally due to noise or other factors.

⇒ **Unplug the power cord and plug it again. In case the unit is still out of order, consult your dealer.**

MP3/WMA

No playback or disc ejected

The disc has unplayable formatted data.

⇒ **Check the file format.**

The CD-R/RWs that are playable on other devices are not playable on this unit.

The playability of some CD-Rs/RWs may depend on the combination of media, recording software and recorder to be used even if these CD-Rs/RWs are playable on other devices such as a PC.

⇒ **Make CD-R/RWs in different combination of media, recording software and recorder after referring to the description about the compressed audio player.**

Sound skipping or noise

There is a flaw or foreign material on the disc.

⇒ **Remove the foreign material, or use a flawless disc.**

Playing VBR (Variable Bit Rate) files may cause sound skipping.

⇒ **Play Non-VBR files.**

Note: Refer to "Notes on MP3/WMA". (⇒ Page 30)

Troubleshooting (continued)

USB

Music is not played back even if the USB device is connected.

The USB device and USB extension cable are not connected correctly.

⇒ **Connect the USB device and USB extension cable correctly.**

There is no music stored in a format that is supported on this unit.

⇒ **Check if there is any music data that can be played stored on the USB device.**

The file system of the USB device is not compatible with this unit.

⇒ **Use a USB device with a FAT12/16/32 file system.**

The current consumption of the USB device exceeds 500 mA.

⇒ **Use a USB device with a current consumption lower than 500 mA.**

“READING” is displayed but music is not played back.

A USB hub is connected.

⇒ **Do not use a USB hub.**

Too many recorded folders/files exist.







⇒ **When there are too many recorded folders/files, it may take a long time to read all of the files.**

Product Servicing

If the suggestions in the charts do not solve the problem, we recommend that you take it to your nearest authorized Panasonic Servicenter. The product should be serviced only by a qualified technician.

Error Display Messages

CD/MP3/WMA

Display	Possible cause → Possible solution
  	<p>The disc is dirty, or is upside down. ⇒ Check the disc.</p> <p>The disc has scratches. ⇒ Check the disc.</p> <p>No operation by some cause. ⇒ Unplug the power cord and plug it again. In case the unit is still out of order, consult your dealer.</p>
	<p>The player for some reason cannot read the file you are trying to play. (File recorded in an unsupported file system, compression scheme, data format, file name extension, damaged data, etc.) ⇒ Select a file that the player can read. Check the type of data recorded on the disc. Create a new disc if necessary.</p>
	<p>A WMA file can be copyrighted. ⇒ The file protected by copyright is not playable.</p>
	<p>No disc in the player. ⇒ Insert disc into the disc slot.</p>

Error Display Messages (continued)

USB

NO USB

A USB device is not connected or the connected device cannot be recognized.
➔ **Use the type of USB memory that is suitable for this unit.**

USB E1

Your USB device has no playable file.
➔ **Download playable file to your USB device.**

USB E2

A USB device the capacity of which exceeds the acceptable current was connected. For some reason, an over-current was detected.
➔ **Use a USB device that has a consumption current of less than 500 mA.**
➔ **Switch the source, and select the USB mode again.**
➔ **Check that the USB connector section is not dirty, and that there is no foreign material.**

USB E3

No operation by some cause.
➔ **Turn off the power and turn on the power again, or turn the key to the ACC OFF position and turn the key to ACC ON position again.** If this does not solve the problem, unplug the power cord and plug it in again. In case the unit is still out of order, consult your dealer.

USB E4

The player for some reason cannot read the file you are trying to play. (File recorded in an unsupported file system, compression scheme, data format, file name extension, damaged data, etc.)
➔ **Confirm that the USB extension cable is firmly connected, and reconnect if not. Select a file that the player can read. Check the type of data stored in the USB device. Format the USB device if necessary.**

USB E5

A WMA file can be copyrighted.
➔ **The file protected by copyright is not playable.**

Maintenance

Cleaning this Unit

Your product is designed and manufactured to ensure a minimum of maintenance. Use a dry soft cloth for routine exterior cleaning. Never use benzine, thinner or other solvents.



To remove stubborn stains

- 1 Moisten the soft cloth in dishwashing soap diluted with water and wring well.
- 2 Wipe lightly. Go over the same surface with a dry cloth.



Note:

- Since there is the possibility of water drops getting inside of the unit, do not directly apply cleanser to the surface.
- Do not scratch the screen with your nails or other hard objects. The resulting scratches or marks will obscure the images.

⚠ Caution

- If water drops or similar wet substances get inside the unit, it may cause a malfunction.

Caution

This product is designed without a fuse inside due to fuses already exist in your vehicle. We would recommend to use fuses of the specified rating (15 A). Using fuses that exceed the prescribed capacity could cause this product to start smoking, ignite or other malfunction.

If your vehicle is without the fuse or a circuit breaker to protect this unit, please your dealer add the specified fuse 15 A or a circuit breaker at the BATTERY lead of your vehicle's harness. Please see page 22 to find out where "BATTERY +12V" is for your dealer adding the fuse or the circuit breaker.

Refer fuse replacement to qualified service personnel. When the fuse blows out, eliminate the cause and have it replaced with the fuse prescribed for this unit by a qualified service engineer. Incorrect replacement of the fuse may lead to smoke, fire, and damage to the product.

Notes on MP3/WMA

Both of MP3 (MPEG Audio Layer-3) and WMA (Windows Media™ Audio) is a format for compressed audio file. These formats allow users to save all the files contained in approximately 10 pieces of existing CDs on one piece of CD-R/RW.

Note: Each of encoding software is not included with this unit.

*MPEG Layer-3 audio coding technology licensed from Fraunhofer IIS and Thomson.

Cautions as to compressed audio files

Common

- High bit rate and high sampling frequency are recommended for high quality sounds.
- Selecting VBR (Variable Bit Rate) is not recommended because playing time is not displayed properly and sound may be skipped.
- The playback sound quality differs depending on the encoding circumstances. For details, refer to the user manual of your own encoding software and writing software.
- Be sure to put an extension compatible with the format.

MP3

- It is recommended to set the bit rate to “128 kbps or more” and “fixed”.

WMA

- It is recommended to set the bit rate to “64 kbps or more” and “fixed”.
- Do not set the copy protect attribute on the WMA file to enable this unit to play back.

Compression formats

Compression method	Bit rate	VBR	Sampling frequency
MPEG 1 audio layer 3 (MP3)	32 k – 320 kbps	Yes	32, 44.1, 48 kHz
MPEG 2 audio layer 3 (MP3)	8 k – 160 kbps	Yes	16, 22.05, 24 kHz
MPEG 2.5 audio layer 3 (MP3)	8 k – 160 kbps	Yes	8, 11.025, 12 kHz
Windows Media Audio Ver. 2, 7, 8, 9*	64 k – 160 kbps	Yes	32, 44.1, 48 kHz

* WMA 9 Professional/LossLess/Voice are not supported.

Caution

Never put an extension indicating compressed audio (such as “.mp3” and “.wma”) to files other than compressed audio files. This may not only produce noise from the speaker damage, but also damage your hearing.

Cautions as to the display of this unit

Display Information

- **CD-TEXT**
Disc title
Track title
- **MP3 (ID3 tag)**
Album name,
Title name/artist name
- **MP3/WMA**
Folder name,
File name
- **WMA (WMA tag)**
Album name,
Title name/artist name

Displayable characters

- Displayable length of file name/folder name: within 30 characters. (Unicode file and folder names are reduced by half in the number of displayable characters.)
- Name files and folders in accordance with the standard of each file system. Refer to the instructions of writing software for details.
- ASCII character set and special characters in each language can be displayed.

ASCII character set

A to Z, a to z, digits 0 to 9, and the following symbols:
(space) ! " # \$ % & ' () * + , - . / : ; < = > ? @ [\] ^ _ ` { | } ~

Notes:

- Characters may be garbled depending on encoding software to be used
- Undisplayable characters and symbols will be converted into an asterisk (*).

Windows Media, and the Windows logo are trademarks, or registered trademarks of Microsoft Corporation in the United States and/or other countries/regions.



Cautions as to compressed audio files

Compressed audio file writing

- Do not save an audio file (CD-DA file) and a compressed audio file on the same disc. Failure to observe this may result in difficulty in playing.
- If compressed audio files formatted with two or more types are saved on the same disc, each format shall have a different folder.
- Do not write files other than compressed audio files.
- Playability may depend on the combination of writing software and disc writer to be used.
- This unit does not support the play list function.
- Write files in a disc-at-once manner unless otherwise needed.
- You can shorten the duration between data read and playback by decreasing the quantity of files or folders, or the depth of the hierarchy.

Supported file systems

■ CD-media

ISO 9660 Level 1/Level 2, Apple Extension to ISO 9660, Joliet, Romeo

Note: Apple HFS, UDF 1.50, Mix CD and CD Extra are not supported.

■ USB-device

File system is FAT12/16/32

Folder selection order/file playback order

■ CD-media/USB-device

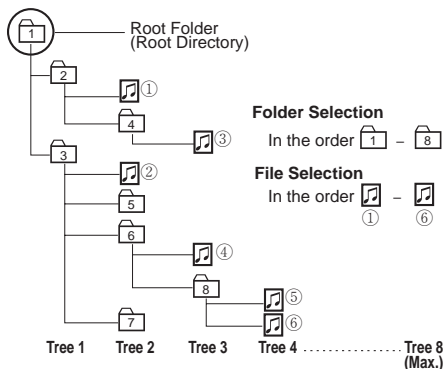

Maximum number of files/folders

- Maximum number of files
CD-media: 999
USB device: 65 535
- Maximum number of files in one folder
CD-media: 255
USB device: 999
- Maximum depth of trees: 8
- Maximum number of folders: 255 (Root folder is included.)

Notes:

- This unit counts the number of folders irrespective of the presence or absence of a compressed audio file.
- If the selected folder does not contain any compressed audio file, the nearest compressed audio file in the order of playback will play.
- Playback order of this unit may be different from that of other compressed audio players even if the same disc is used
- "ROOT" appears when displaying the root folder name.

Common

Copyright

It is prohibited by copyright laws to copy, distribute and deliver copyrighted materials such as music without the approval of copyright holder except enjoying yourself personally.

No warranty

Above description complies with our investigations as of December 2007. It has no warranty for reproducibility and displayability of MP3/WMA.

Notes on Discs

How to hold the disc

- Do not touch the underside of the disc.
- Do not scratch the disc.
- Do not bend disc.
- When not in use, keep disc in the case.

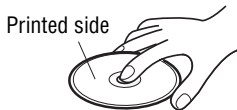

Unusable discs

Do not use discs that fit any of the descriptions given below. Using these discs may damage the discs or cause the unit to malfunction.

- Special discs in a shape which is not round

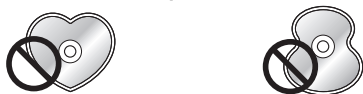

- Partly or wholly transparent disc



Wholly transparent disc*

Partly transparent disc

*Wholly semi-transparent disc may not be played back.

- Discs with adhered labels, etc. on them



Disc with adhered stickers or tape

Labels created by a printer or tape



Protective films or sheets

Disc accessories (stabilizers, etc.)

- Damaged or deformed discs



Shoddily made discs

Discs with cracks, scratches or parts missing



Discs with burrs
Please remove the burrs before use.

Disc insert

The surfaces of new discs tend to be slippery. Therefore, when using such a disc for the first time, it may not load satisfactorily even when it has been inserted into the unit. At a time like this, insert the disc into the unit as far as it will go until it is loaded properly.

- When inserting a disc into or ejecting and removing it from the unit, insert it straight in or eject and remove it straight out in parallel with the unit. Otherwise, the disc may be scratched or marked in the process.
- When inserting a disc, do not put one disc on another. Failure to observe this may cause the discs to be jammed.

Do not leave discs in the following places:

- Direct sunlight
- Near car heaters
- Dirty, dusty and damp areas
- On seats and dashboards

Disc cleaning

Use a dry, soft cloth to wipe from the center outward.

Do not attach any seals or labels to your discs.

Do not write on the disc label in a heavy pen or ballpoint pen.



<Correct>



<Wrong>

Notes on CD-Rs/RWs

- You may have trouble playing back some CD-R/RW discs recorded on CD recorders (CD-R/RW drives), either due to their recording characteristics or dirt, fingerprints, scratches, etc. on the disc surface.
- CD-R/RW discs are less resistant to high temperatures and high humidity than ordinary music CDs. Leaving them inside a car for extended periods may damage and make playback impossible.
- The unit may not successfully playback a CD-R/RW that was made by the combination of writing software, a CD recorder (CD-R/RW drives) and a disc if they are incompatible with one another.
- This player does not play CD-R/RW discs if the session is not closed.
- Be sure to observe the handling instructions of CD-R/RW discs.
- This player does not play CD-R/RW discs which contain other than CD-DA or MP3/WMA data.

Specifications

General

Power Supply:	12 V DC (11 V-16 V) test Voltage 14.4 V, Negative ground
Current consumption:	Less than 2.5 A (CD mode, 0.5 W 4-speaker)
Maximum Power Output:	45 W x 4 channels at 400 Hz, Volume Control maximum
Tone adjustment range:	
Bass:	± 12 dB at 100 Hz
Treble:	± 12 dB at 10 kHz
Power Output:	18 W per channel into 4 ohms, 40 to 30 000 Hz at 3 % THD
Suitable Speaker Impedance:	4-8 Ω
Dimensions (W x H x D):	178 mm x 50 mm x 155 mm {7" x 1 15/16" x 6 1/8"}
Weight:	1.2 kg {2.65 lbs. 42.3 oz.}
USB connector	
USB standard compatibility	1.1/2.0 full speed
File system	FAT12/16/32
Maximum supply current	500 mA
Playable audio format	MP3/WMA
Recommended capacity	Less than 4 GB (1 partition)
Front AUX input	
Input impedance	10 kΩ
Allowable external input	2.0 V
Connector	3.5 mmø Stereo mini pin

FM Stereo Radio

Frequency Range:	87.9 MHz –107.9 MHz
Useable Sensitivity:	12 dBf. (1.1 μV/ 75 Ω, S/N 30 dB)
50 dB Quieting Sensitivity:	17 dBf. (1.8 μV/ 75 Ω)
Frequency Response:	30-15 000 Hz ±3 dB
Alternate Channel Selectivity:	75 dB
Stereo Separation:	35 dB at 1 kHz
Signal/Noise Ratio:	70 dB (Mono)

AM Radio

Frequency range:	530 kHz–1 710 kHz
Usable sensitivity:	28 dB/μV (S/N 20 dB)

Weather Band Radio

Frequency range:	162.400 MHz –162.550 MHz
Usable sensitivity:	3 dB/μV (S/N 20 dB)
Signal/Noise Ratio (40 dB/μV):	50 dB

CD Player

Sampling Frequency:	8 times oversampling
DA Converter:	1 bit/4 DAC System
Error Correction System:	Spot size detection method
Pick-Up Type:	3-beam
Light Source:	Semiconductor laser
Wavelength:	790 nm
Frequency Response:	20 - 20,000 Hz (±1 dB)
Signal to Noise Ratio:	85 dB
Wow and Flutter:	Below measurable limits
Channel Separation:	75 dB

Above specifications comply with EIA standards.

Note: Specifications and the design are subject to modification without notice due to improvements in technology.

Power Output:
18 W RMS x 4 Channels at 4 Ω and ≤ 1%
THD+N
Signal to Noise Ratio:
85 dBA (reference: 1 W into 4 Ω)



**Panasonic Consumer
Electronics Company,
Division of Panasonic
Corporation of North America**
One Panasonic Way, Secaucus,
New Jersey 07094
<http://www.panasonic.com>